

Operating Instructions

Fronius Smart Meter 63A-1

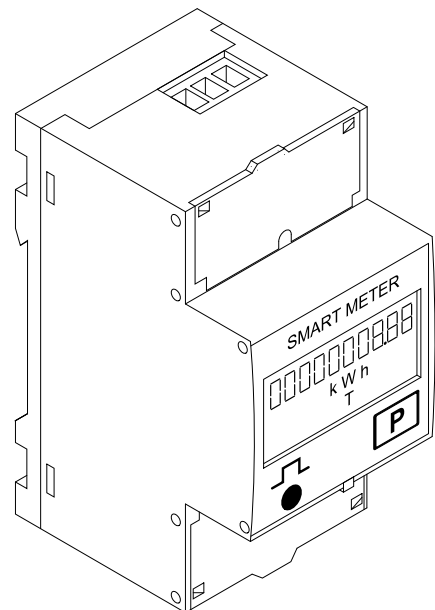

EN-US | Operating instructions



Table of contents

Safety rules.....	4
Explanation of Safety Instructions.....	4
General.....	4
Environmental conditions.....	5
Qualified personnel.....	5
Copyright.....	5
Data backup.....	5
General.....	6
Device description.....	6
Information on the device.....	6
Positioning.....	6
Installation.....	8
Checklist for installation.....	8
Mounting.....	8
Protective circuit.....	8
Cabling.....	9
Connecting the data communication cable to the inverter.....	9
Terminating resistors - explanation of symbols.....	11
Terminating resistors.....	11
Multi meter system - Explanation of symbols.....	12
Modbus participant - Fronius SnapINverter.....	13
Multi meter system - Fronius SnapINverter.....	13
Modbus participant - Fronius GEN24.....	14
Multi meter system - Fronius GEN24 inverter.....	15
Menu structure.....	16
Setting the address of the Fronius Smart Meter.....	16
Reading the Fronius Smart Meter operating parameters.....	17
Commissioning	21
Fronius SnapINverter.....	23
General.....	23
Connect to Fronius Datamanager 2.0.....	23
Configuring the Fronius Smart Meter as the primary meter.....	23
Configuring the Fronius Smart Meter as a secondary meter.....	24
Fronius GEN24 inverter.....	25
General.....	25
Installation using the web browser.....	25
Configuring the Fronius Smart Meter as the primary meter.....	26
Configuring the Fronius Smart Meter as a secondary meter.....	26
Technical data.....	28
Technical data.....	28
Fronius manufacturer's warranty.....	30

Safety rules

Explanation of Safety Instructions

DANGER!

Indicates an immediate danger.

- ▶ Death or serious injury may result if appropriate precautions are not taken.
-

WARNING!

Indicates a possibly dangerous situation.

- ▶ Death or serious injury may result if appropriate precautions are not taken.
-

CAUTION!

Indicates a situation where damage or injury could occur.

- ▶ Minor injury or damage to property may result if appropriate precautions are not taken.
-

NOTE!

Indicates the possibility of flawed results and damage to the equipment.

General

The device has been manufactured using state-of-the-art technology and according to recognized safety standards. If used incorrectly or misused, however, it can cause

- serious or fatal injury to the operator or a third party,
 - and damage to the device and other material assets belonging to the operating company.
-

All persons involved in start-up operation, maintenance and servicing of the device must

- be suitably qualified,
 - have knowledge of and experience in dealing with electrical installations and
 - have fully read and precisely followed these Operating Instructions.
-

The Operating Instructions must always be kept on hand wherever the device is being used. In addition to the Operating Instructions, all applicable local rules and regulations regarding accident prevention and environmental protection must also be followed.

All safety and danger notices on the device

- must be kept in a legible state
 - must not be damaged/marked
 - must not be removed
 - must not be covered, pasted, or painted over.
-

The terminals can reach high temperatures.

Only operate the device when all protection devices are fully functional. If the protection devices are not fully functional, there is a risk of

- serious or fatal injury to the operator or a third party,
 - and damage to the device and other material assets belonging to the operating company.
-

Any safety devices that are not functioning properly must be repaired by an authorized specialist before the device is switched on.

Never bypass or disable protection devices.

For the location of the safety and danger notices on the device, refer to the section headed "General" in the Operating Instructions for the device.

Any equipment malfunctions which might impair safety must be remedied immediately before the device is turned on.

Your personal safety is at stake!

Environmental conditions

Operation or storage of the device outside the stipulated area will be deemed as not in accordance with the intended purpose. The manufacturer accepts no liability for any damage resulting from improper use.

Qualified personnel

The servicing information contained in these Operating Instructions is intended only for the use of qualified service engineers. An electric shock can be fatal. Do not carry out any actions other than those described in the documentation. This also applies to qualified personnel.

All cables and leads must be secured, undamaged, insulated, and adequately dimensioned. Loose connections, scorched, damaged, or under-dimensioned cables and leads must be repaired immediately by an authorized specialist.

Maintenance and repair work must only be carried out by an authorized specialist.

It is impossible to guarantee that externally (aka, third-party) procured parts are designed and manufactured to meet the demands made on them, or that they satisfy safety requirements. Use only original spare parts (also applies to standard parts).

Do not carry out any alterations, installations, or modifications to the device without first obtaining the manufacturer's permission.

Components that are not in perfect condition must be changed immediately.

Copyright

Copyright of these operating instructions remains with the manufacturer.

Text and illustrations were accurate at the time of printing, subject to change. We are grateful for suggestions for improvement and information on any discrepancies in the operating instructions.

Data backup

With regard to data security, the user is responsible for:

- backing up any changes made to the factory settings
- saving and storing personal settings

General

Device description

The Fronius Smart Meter is a bidirectional electricity meter for optimizing self-consumption and recording a household's load characteristic curve. Together with a Fronius inverter or Fronius Datamanager 2.0 and a Fronius data interface, the Fronius Smart Meter allows you to view your own power consumption. The meter measures the energy flow to the loads or to the public grid and forwards the information to the Fronius inverter or Fronius Datamanager 2.0 via the Modbus RTU/RS485 interface.

CAUTION!

Danger due to non-compliance with the safety instructions

Risk of injury and damage to the device as a result.

- ▶ Follow all safety instructions.
 - ▶ Switch off the power supply before establishing the mains connection.
-

Information on the device

Technical data, labels, and safety symbols are located on the Fronius Smart Meter. They must not be removed or painted over. They warn against incorrect operation, as this may result in serious injury and property damage.

Symbols on the rating plate:



CE label

The equipment complies with all the requisite and relevant standards and directives that form part of the relevant EU directive, and therefore is permitted to display the CE label.



RCM (Regulatory Compliance Mark)

All relevant regulatory requirements in Australia and New Zealand are complied with in terms of safety and electromagnetic compatibility, as well as special requirements for radio equipment.



WEEE label

To comply with European Directive 2012/19/EU on Waste Electrical and Electronic Equipment and its implementation as national law, electrical equipment that has reached the end of its life must be collected separately and returned to an approved recycling facility. Any device that you no longer require must be returned to your distributor, or you must locate the approved collection and recycling facilities in your area. Ignoring this European Directive may have potentially adverse effects on the environment and your health.

Positioning

The Fronius Smart Meter can be installed at two possible locations in the system, at the feed-in point and at the consumption point.

Positioning at the feed-in point

The positioning of the Fronius Smart Meter at the feed-in point.

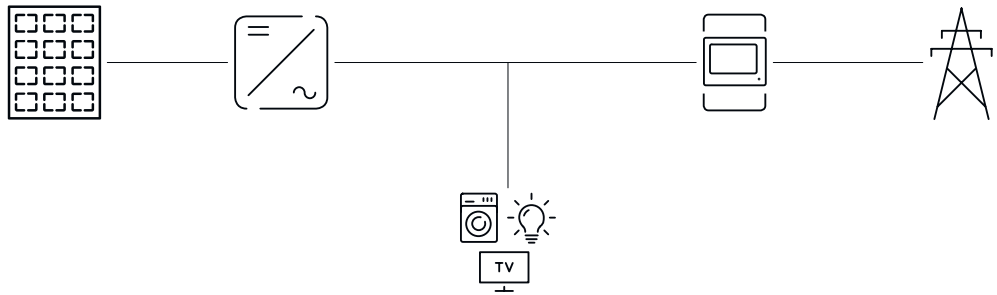

Positioning at the consumption point

The positioning of the Fronius Smart Meter at the consumption point.

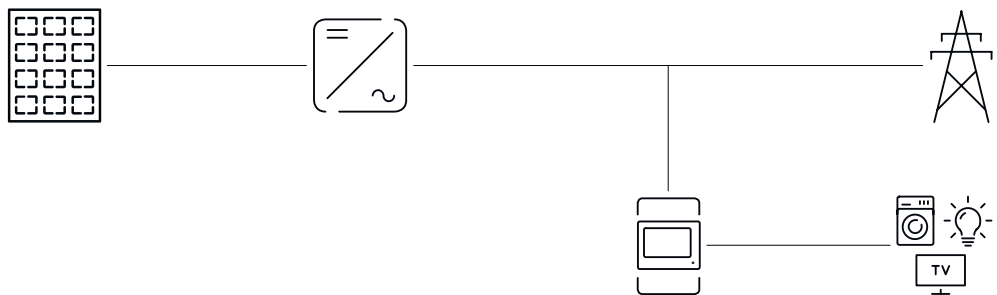

Installation

Checklist for installation

For installation information, see the following chapters:

- 1 Switch off the power supply before establishing a grid connection.
- 2 Mount the Fronius Smart Meter (see [Mounting](#) on page 8).
- 3 Connect automatic circuit breakers or automatic circuit breakers and disconnectors (see [Protective circuit](#) on page 8).
- 4 Connect the mains cable to the Fronius Smart Meter (see [Cabling](#) on page 9).
- 5 Connect the output terminals of the Fronius Smart Meter to the Fronius inverter (see [Connecting the data communication cable to the inverter](#) on page 9).
- 6 If necessary, set terminating resistors (see [Terminating resistors](#) on page 11).
- 7 Tug on each wire and plug to make sure that they are securely connected to the terminal blocks.
- 8 Switch on the power supply to the Fronius Smart Meter.
- 9 Check the firmware version of the Fronius inverter. To ensure compatibility between the inverter and the Fronius Smart Meter, the software must always be kept up to date. The update can be started via the inverter web page or using Solar.web.
- 10 If several Fronius Smart Meters are installed in the system, set the address (see "Setting the address" under [Setting the address of the Fronius Smart Meter](#) on page 16).
- 11 Configure and commission the meter (see [Commissioning](#) on page 21).

Mounting

The Fronius Smart Meter can be mounted on a 35 mm DIN rail. The housing comprises two modules according to DIN 43880.

Protective circuit

The Fronius Smart Meter is a hard-wired device and requires a disconnecting device (circuit breaker, switch, or disconnector) and overcurrent protection (automatic circuit breaker).

The Fronius Smart Meter consumes just 10-30 mA, so that the nominal capacity of all switches, disconnectors, fuses, and/or automatic circuit breakers is determined by the wire gauge, mains voltage, and required breaking capacity.

- Switches, disconnectors, and circuit breakers must be within sight and located as close as possible to the Fronius Smart Meter; they must also be easy to use.
- Use automatic circuit breakers that are rated for max. 63 A.
- To monitor more than one mains voltage, use connected automatic circuit breakers.
- The automatic circuit breakers must protect the grid terminal, which is marked L1. In rare cases where the neutral conductor has overcurrent protection, the overcurrent protection device must interrupt both neutral and non-grounded cables concurrently.
- The circuit protection/disconnecting device must satisfy the requirements of IEC 60947-1 and IEC 60947-3, as well as all national and local regulations for electrical systems.

Cabling

WARNING!

Danger from mains voltage.

An electric shock can be fatal.

- Switch off the power supply before connecting the mains voltage inputs to the Fronius Smart Meter.

IMPORTANT!

Do not install more than one cable per screw terminal. If necessary, use terminal blocks.

Current path connection cross-section:

- Wire (rigid): min. 1 mm² / max. 16 mm²
- Wire (flexible): min. 1 mm² / max. 10 mm²
- Recommended torque: 1.2 Nm / max. 1.4 Nm

Data communication and neutral conductor connection cross-section:

- Wire (rigid): min. 0.05 mm² / max. 4 mm²
- Wire (flexible): min. 0.05 mm² / max. 2.5 mm²
- Recommended torque: 0.5 Nm / max. 0.8 Nm

Connect each voltage cable to the terminal strip as shown in the graphic below.

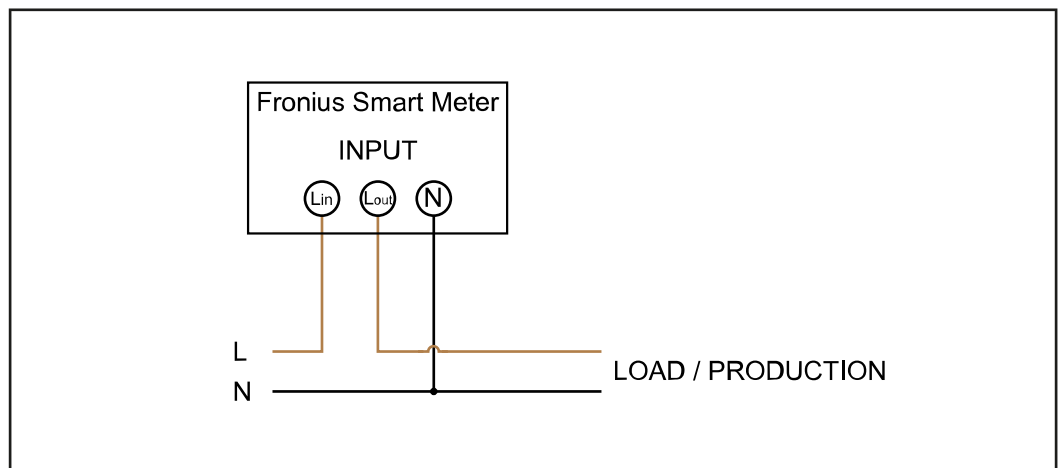

Connecting the data communication cable to the inverter

Fronius SnapINverter:

Connect the data communication connections of the Fronius Smart Meter to the Fronius system monitoring in the inverter. Several Smart Meters can be installed in the system, see chapter [Multi meter system - Fronius SnapINverter](#) on page [13](#).

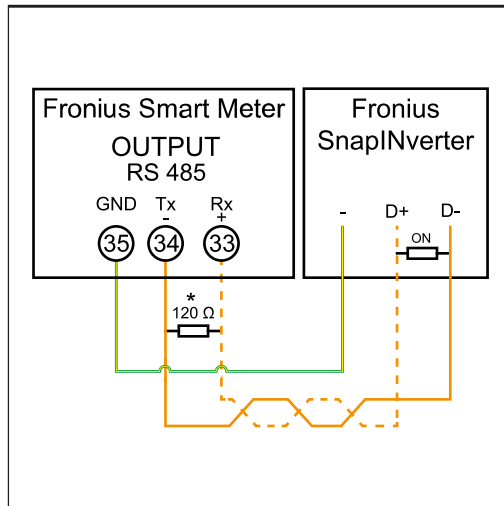

- 1 Connect 35 to -.
- 2 Connect 34 to D-.
- 3 Connect 33 to D+.

Fronius GEN24 inverter:

Connect the data communication connections of the Fronius Smart Meter to the Modbus interface of the Fronius GEN24 inverter. Several Smart Meters can be installed in the system, see chapter [Multi meter system - Fronius GEN24 inverter](#) on page 15.

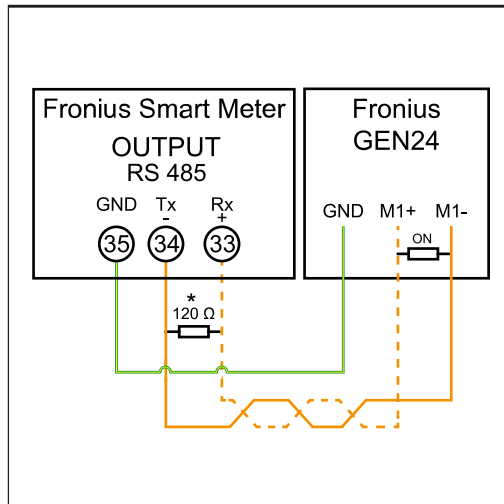

- 1 Connect 35 to GND.
- 2 Connect 34 to M1-.
- 3 Connect 33 to M1+.

IMPORTANT!

More information on successful commissioning.

Note the following information about connecting the data communication cable to the inverter.

- ▶ Use cables of type CAT5 or higher.
- ▶ The maximum cable length between the Fronius inverter and Fronius Smart Meter is 300 meters.
- ▶ Use a mutual twisted cable pair for data lines that belong together (D+, D- and M1+, M1-).
- ▶ If the output cables are close to the grid cabling, use wires or cables that are designed for 300 V to 600 V (never less than the operating voltage).
- ▶ Use double-insulated or sheathed output cables when they are close to bare conductors.
- ▶ Use shielded twisted pair cables to avoid faults.
- ▶ The outputs of the Fronius Smart Meter are electrically isolated from hazardous voltages.

Terminating resistors - explanation of symbols



Inverter in the system
z. e.g., Fronius Symo



Meter - Fronius Smart Meter
Terminating resistor R 120 Ohm is included in the scope of supply.



Fronius or third-party device, connection via Modbus RTU
e.g., Fronius Ohmpilot, battery, etc.



Terminating resistor
R 120 Ohm

Terminating resistors

Due to interference, the use of terminating resistors according to the following overview is recommended for flawless operation.

OPTION 1

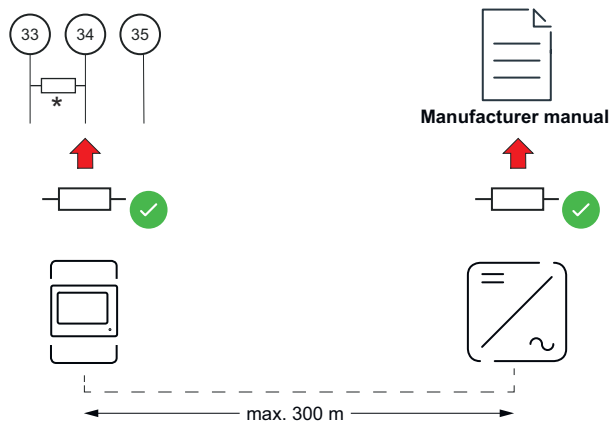

OPTION 2

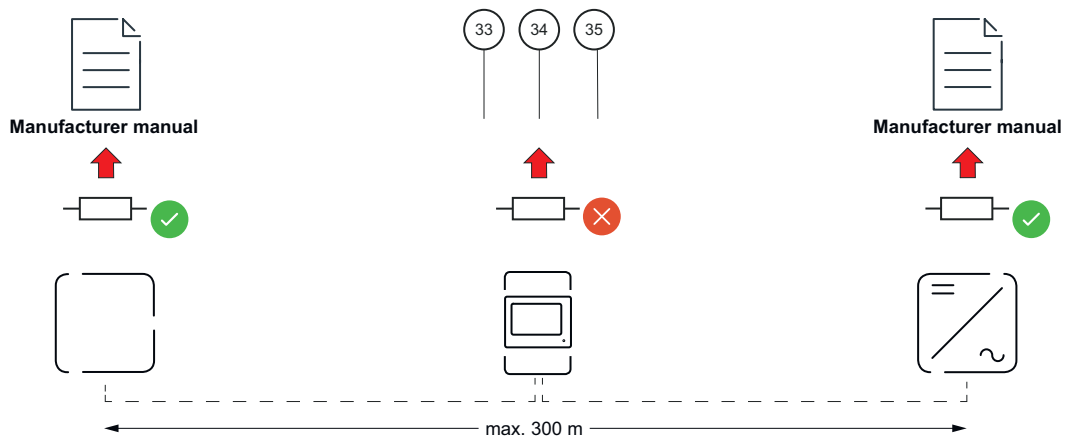

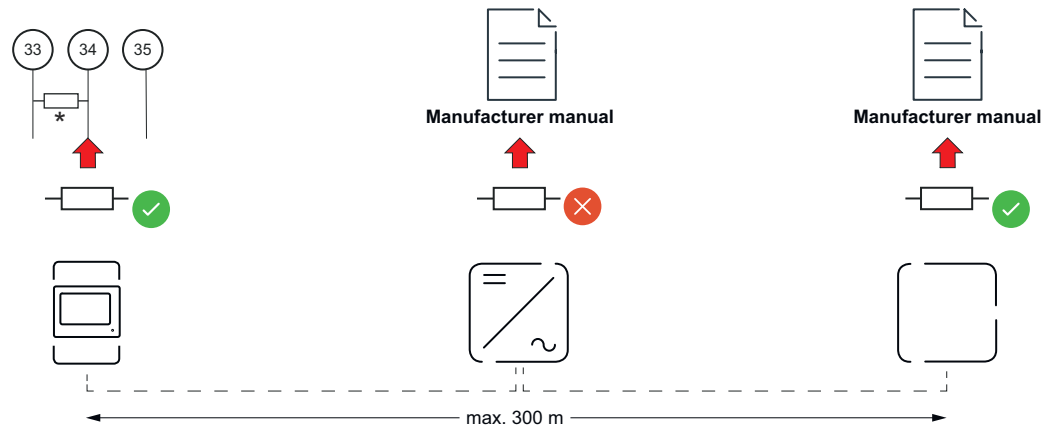
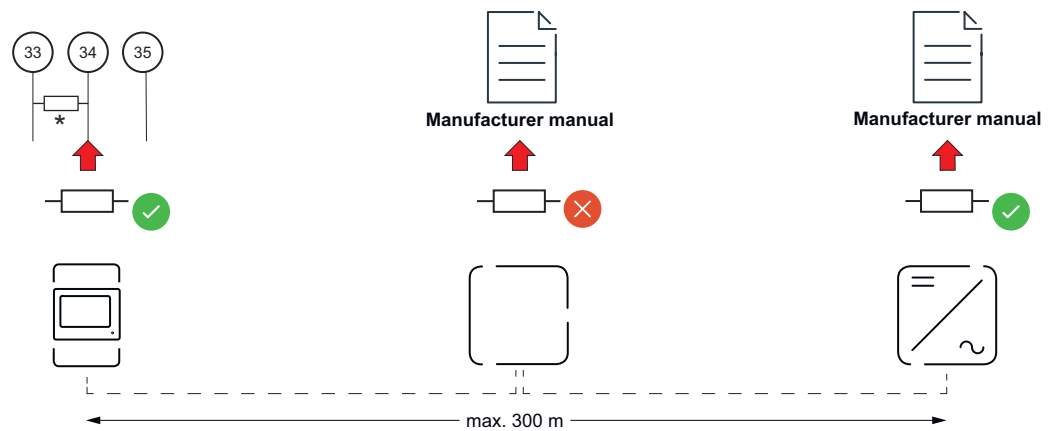
OPTION 3**OPTION 4**

* The terminating resistor on the Fronius Smart Meter is installed between **33** and **34**. The terminating resistor R 120 Ohm is included with the Fronius Smart Meter.

Multi meter system - Explanation of symbols

Grid

Supplies the loads in the system if insufficient power is being generated by the PV modules or supplied by the battery.

Inverter in the system

e.g. Fronius Primo, Fronius Symo, etc.

Utility meter

Measures the metering data relevant for the billing of electricity quantities (primarily the kilowatt hours of grid purchases and grid power feed). On the basis of the data relevant for billing, the electricity retailer invoices a grid purchase and the purchaser of the surplus pays for the grid power feed.

Primary meter

Records the load curve of the system and makes the measured data available for energy profiling in Fronius Solar.web. The primary meter also regulates the dynamic feed-in control.

**Secondary meter**

Records the load curve of individual loads and producers (e.g. washing machine, lights, television, heat pump, etc.) in the consumption branch and makes the measured data available for energy profiling in Fronius Solar.web.

**Modbus RTU, Third-party device**

e.g. Fronius Ohmpilot, battery, etc.

**Loads in the system**

e.g. washing machine, lamps, TV, etc.

**Additional loads in the system**

e.g. heat pump

**Additional producers in the system**

e.g. wind power plant

**Terminating resistor**

R 120 Ohm

Modbus participant - Fronius SnapINverter

A maximum of 4 Modbus stations can be connected to the Modbus connection terminal.

IMPORTANT!

Only one primary meter, one battery and one Ohmpilot can be connected per inverter. Due to the high data transfer of the battery, the battery occupies 2 subscribers.

Example:

Input	Battery	Fronius Ohmpilot	Number of primary meters	Number of secondary meters
Modbus	✓	✓	1	0
	✓	✗	1	1
	✗	✓	1	2
	✗	✗	1	3

Multi meter system - Fronius SnapINverter

If several Fronius Smart Meters are installed, a separate address must be set for each one (see [Setting the address of the Fronius Smart Meter](#) on page 16). The primary meter always receives the address 1. All other meters are numbered consecutively in the address range from 2 to 14. Different Fronius Smart Meter power categories can be used together.

IMPORTANT!

Use no more than 3 secondary meters in the system. To avoid interference, it is

recommended to install the terminating resistors according to the chapter **Terminating resistors** on page **11**.

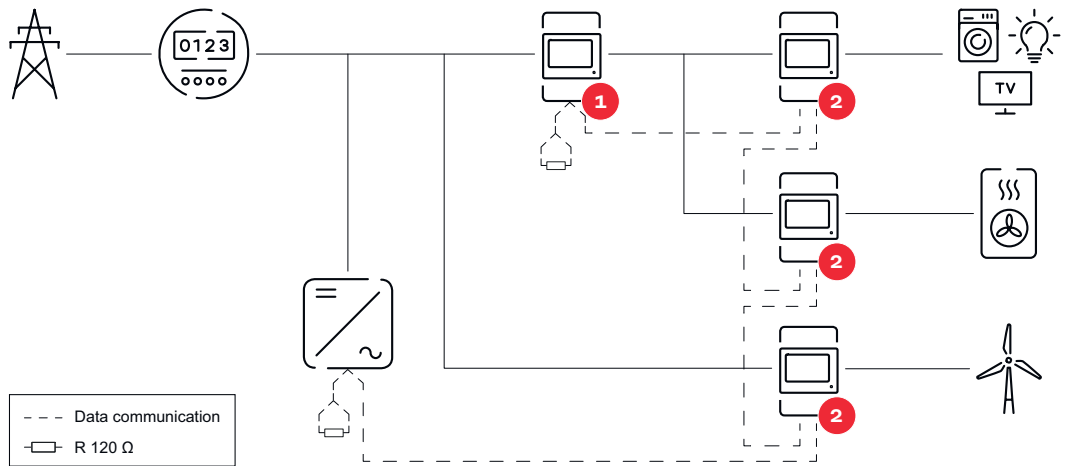

Position of the primary meter in the consumption branch. *Termination resistor R 120 Ohm

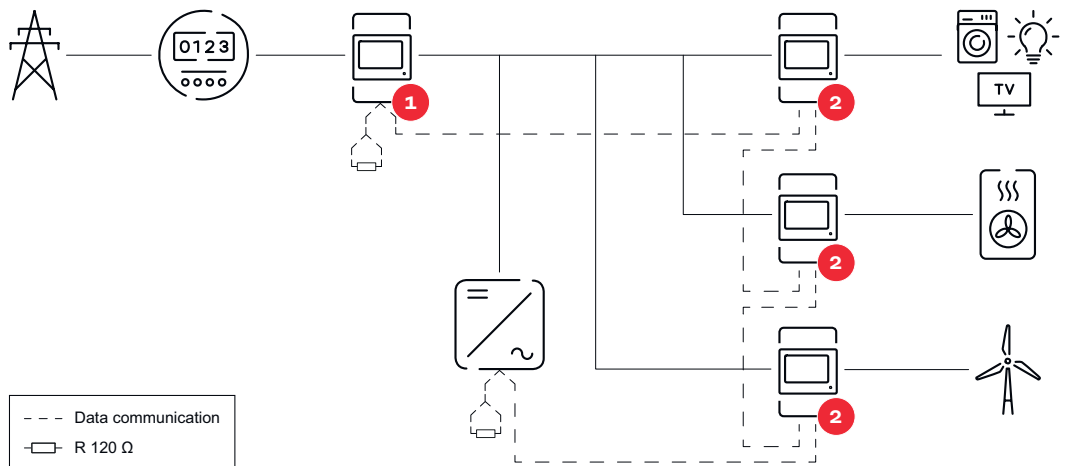

Position of the primary meter at the feed-in point. *Termination resistor R 120 Ohm

The following must be observed in a multi meter system:

- Each Modbus address is assigned only once.
- Place the terminating resistors individually for each channel.

Modbus participant - Fronius GEN24

The inputs M0 and M1 can be freely selected. A maximum of 4 Modbus participants can be connected to the Modbus terminal on the inputs M0 and M1.

IMPORTANT!

Only one primary meter, one battery and one Ohmpilot can be connected per inverter. Due to the high data transfer of the battery, the battery occupies 2 subscribers.

Example 1:

Input	Battery	Fronius Ohmpilot	Number of primary meters	Number of secondary meters
Modbus 0 (M0)	✗	✗	0	4
	✓	✗	0	2
	✓	✓	0	1
Modbus 1 (M1)	✗	✗	1	3

Example 2:

Input	Battery	Fronius Ohmpilot	Number of primary meters	Number of secondary meters
Modbus 0 (M0)	✗	✗	1	3
Modbus 1 (M1)	✗	✗	0	4
	✓	✗	0	2
	✓	✓	0	1

Multi meter system - Fronius GEN24 inverter

If several Fronius Smart Meters are installed, a separate address must be set for each one (see [Setting the address of the Fronius Smart Meter](#) on page 16). The primary meter always receives the address 1. All other meters are numbered consecutively in the address range from 2 to 14. Different Fronius Smart Meter power categories can be used together.

IMPORTANT!

Use no more than Use 7 secondary meters in the system. To avoid interference, it is recommended to install the terminating resistors according to the chapter [Terminating resistors](#) on page 11.

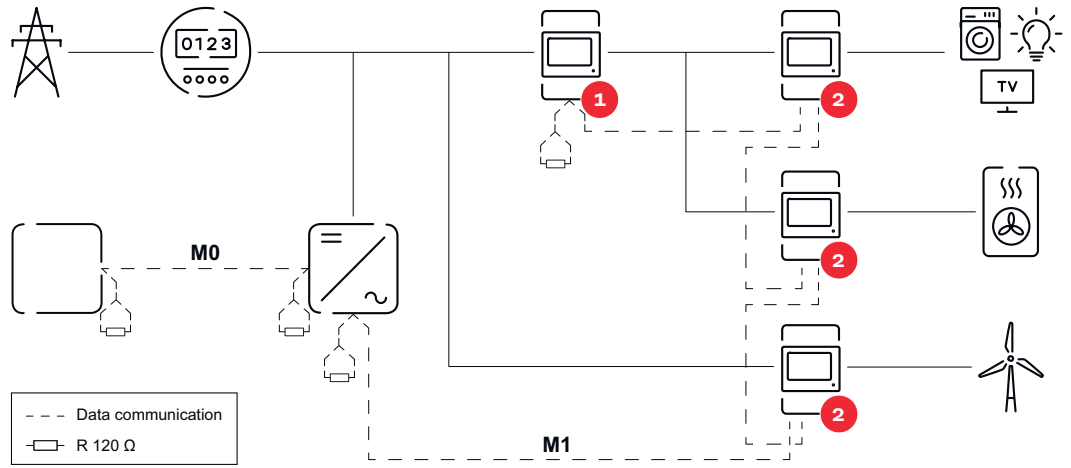

Position of the primary meter in the consumption branch. *Termination resistance R 120 Ohm

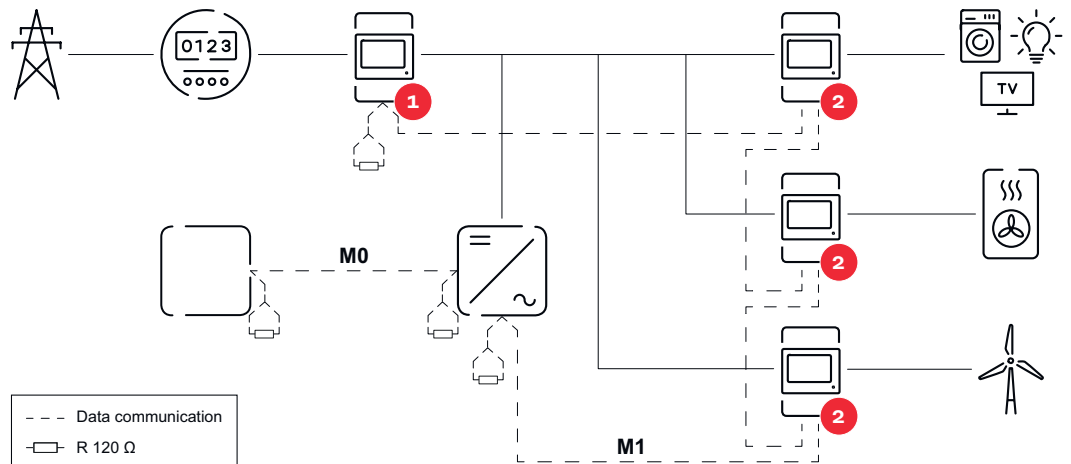

Position of the primary meter at the feed-in point. *Termination resistance R 120 Ohm

The following must be observed in a multi meter system:

- Connect the primary meter and the battery to different channels (recommended).
- Distribute the remaining Modbus participants evenly.
- Each Modbus address is assigned only once.
- Place the terminating resistors individually for each channel.

Menu structure

A graphic view of the menu structure can be found in the User Information that is supplied as standard.

Setting the address of the Fronius Smart Meter

Symbol	Name	Event	Function
	Prog	1 x	Increases the set value
	Prog	2 seconds	Proceeds to the next menu item

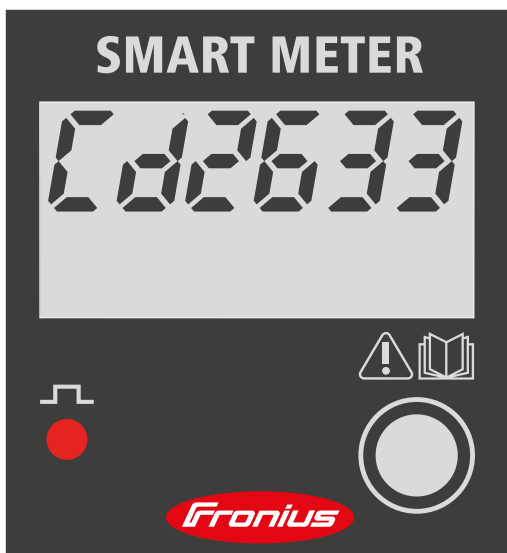

- 1 Press "Prog" for 2 seconds to call up code entry.
- 2 Enter the password "2633". Increase the value with "Prog".

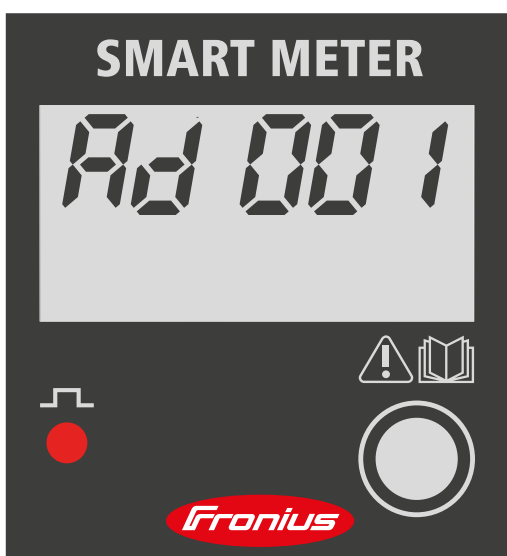





- 3 Press "Prog" for 2 seconds to change to the menu item "Ad" (address).
- 4 Set the relevant address.
- Permissible values: 1 - 14









IMPORTANT!

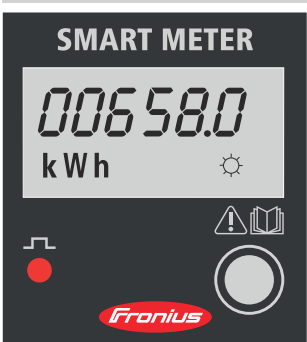



Skip all other settings and leave them unchanged.



Reading the Fronius Smart Meter operating parameters

Symbol	Name	Event	Function
	Prog	1 x 	Continue to the next screen
	Prog	2 seconds 	Reset value / switch to basic settings

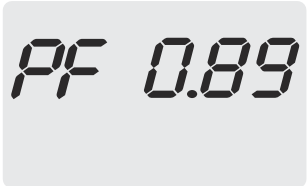
The following illustrations are symbolic representations. The values displayed vary for each individual unit.

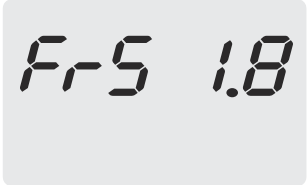
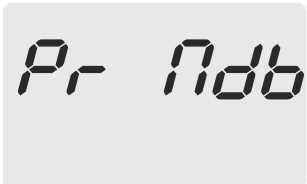
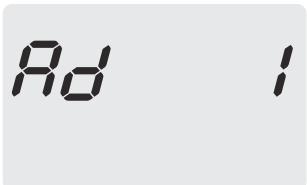
Display	Description
 <p>SMART METER 00658.0 kWh</p>	<p>Total active energy consumed</p>
 <p>00058.0 kWh</p>	<p>Total active energy produced</p> <p>Press for 2 seconds to reset the value</p>
 <p>00658.0 khVAF</p>	<p>Total reactive energy</p>
 <p>00058.0 khVAF</p>	<p>Partial reactive energy</p>
 <p>45.00 A</p>	<p>Current</p> <p>Press for 2 seconds to reset the value</p>
 <p>230.0 V</p>	<p>Voltage</p>
 <p>2.454 k W</p>	<p>Effective power</p>
 <p>4.254 k VAF</p>	<p>Reactive power</p>

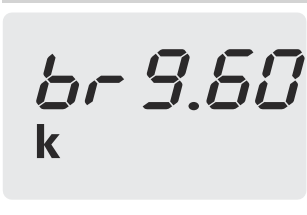
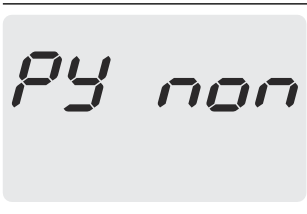
Display	Description
 <p>4.254 k VA</p>	Apparent power
 <p>50.0 F</p>	Frequency
 <p>PF 0.89</p>	Power factor
 <p>00089 h</p>	Operating hours Press for 2 seconds to reset the value
Display	Description
 <p>Fr-S 1.8</p>	Internal operating data Press to return to the "Total active energy consumed" display. Press for 2 seconds to go to the basic settings
 <p>Pr Ndb</p>	Protocol communication
 <p>Ad 1</p>	Address RS485

Display	Description
	Speed RS485
	Parity bit
	Version

Commissioning

Fronius SnapINverter

General

IMPORTANT! Settings in the "Meter" menu item may only be entered by staff trained to do so!

The service password must be entered for the "Meter" menu item.

Three-phase or one-phase Fronius Smart Meters may be used. In both cases, selection is made via the "Fronius Smart Meter" item. The Fronius Datamanager automatically detects the meter type.

One primary meter and several secondary meters can be selected. The primary meter must be configured before a secondary meter can be chosen.

Connect to Fronius Datamanager 2.0

Access Point:

Activate the WiFi access point of the inverter:

- 1 Select the **Setup** menu on the inverter display.
- 2 Navigate to **WiFi Access Point**.
 - ✓ *Network (SS) and password (PW) are displayed.*
- 3 Activate the **WiFi Access Point** with the Enter ↵ key.

Establish the connection from the inverter's WiFi access point to the PC:

- 1 Establish the connection to the inverter in the network settings (the inverter is displayed with the name "Fronius_240.XXXXXX").
 - 2 Enter and confirm the password from the inverter display.
 - 3 In the browser's address bar, enter the IP address <http://192.168.250.181> and confirm.
- ✓ *The Fronius Datamanager 2.0 start page is displayed.*
-

LAN:

- 1 Connect the Fronius Datamanager and computer with a LAN cable.
 - 2 Place the Fronius Datamanager 2.0 IP switch in the "A" position.
 - 3 In the browser's address bar, enter the IP address <http://169.254.0.180> and confirm.
-

Configuring the Fronius Smart Meter as the primary meter

- 1 Go to the Fronius Datamanager website.
 - Open the web browser.
 - In the address bar of the browser, enter the IP address (IP address for WLAN: 192.168.250.181, IP address for LAN: 169.254.0.180) or the host and domain name of the Fronius Datamanager and confirm.
 - The Fronius Datamanager website will be displayed.
- 2 Click the **"Settings"** button.
- 3 Log in to the login area with the **"service"** user and the service password.
- 4 Open the **"Meter"** menu area.
- 5 Select the primary meter from the drop-down list.
- 6 Click the **"Settings"** button.

- 7 In the pop-up window, set the position of the meter (feed-in point or consumption point). For more information on the position of the Fronius Smart Meter, see [Positioning](#) on page 6.
- 8 Click the **"Ok"** button when the OK status is displayed. If the *Timeout* status is displayed, try again.
- 9 Click the button to save the settings.

The Fronius Smart Meter is configured as a primary meter.

The **"Current general view"** menu area displays the power of the PV modules, self-consumption, the energy fed into the grid, and the battery charge (if available).

Configuring the Fronius Smart Meter as a secondary meter

- 1 Go to the Fronius Datamanager website.
 - Open the web browser.
 - In the address bar of the browser, enter the IP address (IP address for WLAN: 192.168.250.181, IP address for LAN: 169.254.0.180) or the host and domain name of the Fronius Datamanager and confirm.
 - The Fronius Datamanager website will be displayed.
- 2 Click the **"Settings"** button.
- 3 Log in to the login area with the **"service"** user and the service password.
- 4 Open the **"Meter"** menu area.
- 5 Select the secondary meter from the drop-down list.
- 6 Click the **"Add"** button.
- 7 Enter the name of the secondary meter in the **"Name"** input field.
- 8 Enter the previously assigned address in the **"Modbus address"** input field.
- 9 Add meter description.
- 10 Click the button to save the settings.

The Fronius Smart Meter is configured as a secondary meter.

Fronius GEN24 inverter

General

IMPORTANT! Settings in the "Device configuration" menu item may only be entered by staff trained to do so!

The service password must be entered for the "Device configuration" menu item.

Three-phase or one-phase Fronius Smart Meters may be used. In both cases, selection is made via the "Components" menu area. The meter type is determined automatically.

One primary meter and several secondary meters can be selected. The primary meter must be configured before a secondary meter can be chosen.

Installation using the web browser

WLAN:

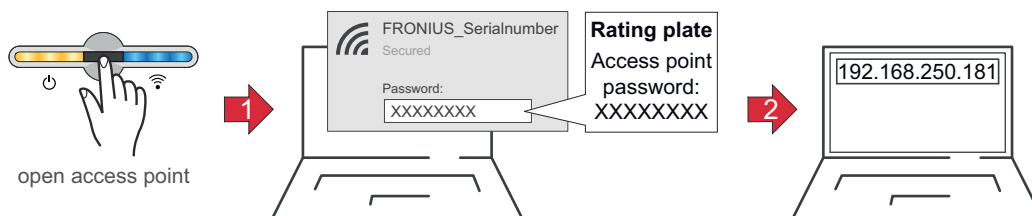

- 1 Open the access point by touching the sensor
 ✓ *Communication LED flashes blue.*
- 2 Establish the connection to the inverter in the network settings (the inverter is displayed with the name "FRONIUS_" and the serial number of the device).
- 3 Enter the password from the rating plate and confirm.
 IMPORTANT!
 To enter the password on a Windows 10 operating system, the link "**Connect using a security key instead**" must first be activated to establish a connection with the password.
- 4 In the browser address bar, enter and confirm the IP address 192.168.250.181. The installation wizard is opened.
- 5 Follow the installation wizard in the individual sections and complete the installation.
- 6 Add the system components in Fronius Solar.web and start up the PV system.

The network wizard and the product setup can be carried out independently of each other. A network connection is required for the Fronius Solar.web installation wizard.

Ethernet:

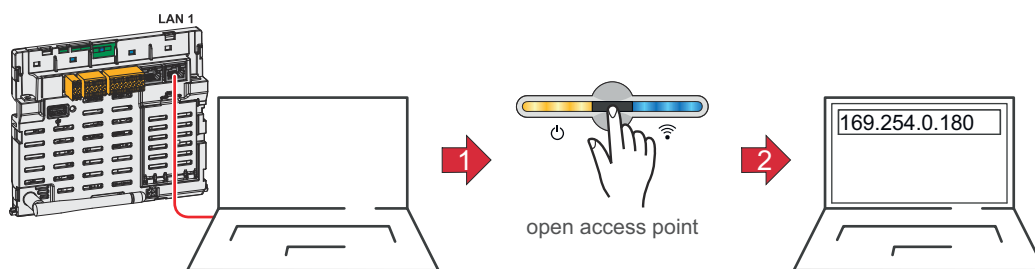

- 1 Establish a connection to the inverter (LAN1) with a network cable (CAT5 STP or higher).
- 2 Open the access point by touching the sensor once 
✓ *Communication LED flashes blue.*
- 3 In the browser address bar, enter IP address 169.254.0.180 and confirm. The installation wizard is opened.
- 4 Follow the installation wizard in the individual sections and complete the installation.
- 5 Add the system components in Fronius Solar.web and start up the PV system.

The network wizard and the product setup can be carried out independently of each other. A network connection is required for the Fronius Solar.web installation wizard.

Configuring the Fronius Smart Meter as the primary meter

- 1 Access the inverter website.
 - Open the web browser.
 - In the address bar of the browser, enter the IP address (IP address for WLAN: 192.168.250.181, IP address for LAN: 169.254.0.180) or the host and domain name of the inverter and confirm.
 - The inverter website is displayed.
- 2 Click the **"Device configuration"** button.
- 3 Log in to the login area with the **"Technician"** user and the technician password.
- 4 Access the **"Components"** menu area.
- 5 Click the **"Add component"** button.
- 6 In the "Position" drop-down list, set the position of the meter (feed-in point or consumption point). For more information on the position of the Fronius Smart Meter, see [Positioning](#) on page 6.
- 7 Click the **"Add"** button.
- 8 Click the **"Save"** button to save the settings.

The Fronius Smart Meter is configured as a primary meter.

Configuring the Fronius Smart Meter as a secondary meter

- 1 Access the inverter website.
 - Open the web browser.
 - In the address bar of the browser, enter the IP address (IP address for WLAN: 192.168.250.181, IP address for LAN: 169.254.0.180) or the host and domain name of the inverter and confirm.
 - The inverter website is displayed.
- 2 Click the **"Device configuration"** button.

- 3 Log in to the login area with the "**Technician**" user and the technician password.
- 4 Access the "**Components**" menu area.
- 5 Click the "**Add component**" button.
- 6 In the "**Position**" drop-down list, select the meter type (producer/load meter).
- 7 Enter the previously assigned address in the "**Modbus address**" input field.
- 8 Enter the name of the meter in the "**Name**" input field.
- 9 In the "Category" drop-down list, select the category (producer or load).
- 10 Click the "**Add**" button.
- 11 Click the "**Save**" button to save the settings.

The Fronius Smart Meter is configured as a secondary meter.

Technical data

Technical data

Modbus transmission speed: 9600 baud

Parity bit: None

Software version: Datamanager 3.7.2 / Energypackage 1.3.3

Input	
Nominal voltage (1-phase) Operating range	230 V ±10%
Self-consumption - voltage path (max. voltage)	4 VA (1.9 W) for 264 V
Nominal frequency Tolerance	50 - 60 Hz 47 to 61 Hz
Nominal current, I _b	10 A
Maximum current, I _{max}	63 A
Starting current	40 mA
Short-time overload (EN/IEC 62053-21, EN/IEC 62053-23)	30 I _{max} / 0.5 s
Self-consumption - current path (max. current)	1.5 W
Power factor Operating range (EN/IEC 62053-21, EN/IEC 62053-23)	cosφ 0.5 ind to 0.8 cap
Current total harmonic distortion	In acc. with EN 62053-21

Output	
Pulse output Optical relay with NO contact SPST-NO, floating	
Contact load	110 V DC/AC - 50 mA
Pulse value (programmable)	1 imp/Wh - 10 Wh - 100 Wh - 1 kWh
Pulse duration (programmable)	50 - 100 - 150 - 200 - 300 - 400 - 500 ms
RS485 communication Electrically isolated from measuring input	
Standard	RS485 - 3 conductors
Transmission	Serial, asynchronous
Protocol	Compatible with Modbus RTU
Addresses	1 to 255
Number of bits	8
Stop bit	1
Parity bit	None - odd - even
Baud rate	2400 - 4800 - 9600 - 19200 bit/s
Response time	≤ 200 ms

Insulation (EN/IEC 62052-11, 62053-21)	
Installation category	III
Pollution degree	2
Insulation voltage	300 V

Electromagnetic compatibility	
Emission test	In acc. with EN/IEC 62052-11, EN 50470
Immunity test	In acc. with EN/IEC 62052-11, EN 50470

Operating conditions	
Reference temperature	23°C (±2°C)
Operating range	-25 to 55 °C
Temperature limit for storage and transport	-40 to 70 °C
Tropical model	
Max. power loss (for thermal dimensioning of the switch cabinet)	≤ 4 W
Mechanical environment Electromechanical environment	M1 E2

Housing	
Housing	2 modules according to DIN 43880
Sealable front and terminal cover	
Connection	Screw connection
Mounting	Can be snapped onto 35 mm DIN rail
Housing material	Polycarbonate, self-extinguishing
Degree of protection (EN 60529)	IP51 front, IP20 connections
Weight	250 grams

Screw terminals	
Measuring input	
Wire (rigid)	Min. 1 mm ² / max. 16 mm ²
Wire (flexible)	Min. 1 mm ² / max. 10 mm ²
Recommended torque	1.2 Nm / max. 1.4 Nm
Output	
Wire (rigid)	Min. 0.05 mm ² / max. 4 mm ²
Wire (flexible)	Min. 0.05 mm ² / max. 2.5 mm ²
Recommended torque	0.5 Nm / max. 0.8 Nm

Fronius manufacturer's warranty

Detailed, country-specific warranty conditions are available at www.fronius.com/solar/warranty.

To obtain the full warranty period for your newly installed Fronius product, please register at www.solarweb.com.



fronius.com/en/solar-energy/installers-partners/products-solutions/monitoring-digital-tools

**MONITORING &
DIGITAL TOOLS**

Fronius International GmbH

Froniusstraße 1
4643 Pettenbach
Austria
contact@fronius.com
www.fronius.com

At www.fronius.com/contact you will find the contact details of all Fronius subsidiaries and Sales & Service Partners.