

OPzV12-200(12V200Ah)

RITAR®

Ritar OPzV series is Valve Regulated Lead Acid battery that adopts immobilized GEL and Tubular Plate technology to offer high reliability and performance. The Battery is designed and manufactured according to DIN standards and with die-casting positive grid and patented formula of active material OPzV series exceeds DIN standard values with more than 18 years floating design life at 25 °C ,and It is the best solution for cyclic use under extreme operating conditions.

Specification

Cells Per Unit	6
Voltage Per Unit	12
Nominal Capacity	200Ah@10hr-rate to 1.80V per cell @25°C
Weight	Approx. 73.0 Kg (Tolerance±1.5%)
Internal Resistance	Approx. 5.0 mΩ
Terminal	F14(M8)
Max. Discharge Current	2000A (5 sec)
Design Life	18 years (floating charge)
Maximum Charging Current	40.0 A
Reference Capacity	C24 201.4AH C48 212.8AH C72 223.4AH C100 228.0AH C120 232.6AH C240 246.2AH
Float Charging Voltage	13.5 V~13.8 V @ 25°C Temperature Compensation: -3mV/°C/Cell
Cycle Use Voltage	14.2 V~14.4 V @ 25°C Temperature Compensation: -4mV/°C/Cell
Operating Temperature Range	Discharge: -40°C~60°C Charge: -20°C~50°C Storage: -40°C~60°C
Normal Operating Temperature Range	25°C±5°C
Self Discharge	RITAR Valve Regulated Lead Acid (VRLA) batteries can be stored for up to 6 months at 25°C and then recharging is recommended. Monthly Self-discharge ratio is less than 2% at 25°C. Please charged batteries before using.
Container Material	A.B.S. UL94-HB, UL94-V0 Optional.



Dimensions

Unit: mm

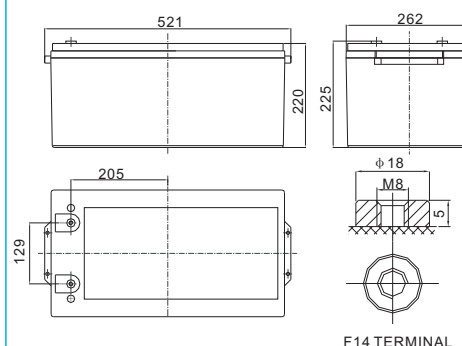

Length	260±1mm (10.2 inches)
Width	169±1mm (6.65 inches)
Height	211±1mm (8.31 inches)
Total Height	218±1mm (8.58 inches)
Torque Value	10~12 N*m

Constant Current Discharge Characteristics :A(25°C)

F.V/ Time	30min	1h	2h	3h	4h	5h	6h	8h	10h	20h
1.90V	98.40	78.00	55.02	41.71	34.20	29.55	26.60	20.76	17.80	9.347
1.87V	110.0	86.00	59.02	44.23	36.10	31.09	28.20	21.73	18.60	9.764
1.83V	126.0	96.00	64.00	47.16	38.00	32.43	29.20	22.70	19.40	10.19
1.80V	140.0	104.0	66.40	48.49	38.76	33.20	30.00	23.28	20.00	10.50
1.75V	156.0	111.4	69.42	50.44	39.40	34.00	30.60	23.67	20.40	10.71
1.70V	172.0	115.0	71.42	51.42	40.09	34.40	31.00	23.86	20.60	10.81
1.65V	177.4	122.2	73.82	52.80	40.66	34.80	31.40	24.06	20.80	10.92
1.60V	185.0	126.4	76.62	55.02	41.80	35.40	31.80	24.25	21.00	11.03

Constant Power Discharge Characteristics : WPC(25°C)

F.V/ Time	30min	1h	2h	3h	4h	5h	6h	8h	10h	20h
1.90V	188.4	149.8	106.3	80.81	66.96	58.20	52.60	41.52	36.28	19.04
1.87V	207.3	162.6	112.7	84.67	70.52	61.00	55.60	43.26	37.83	19.86
1.83V	232.1	177.3	120.0	89.04	74.00	63.40	57.40	44.81	39.19	20.57
1.80V	253.6	189.1	124.0	91.04	75.41	64.80	58.80	45.79	40.16	21.08
1.75V	275.2	197.6	128.0	93.85	76.37	66.40	59.80	46.36	40.74	21.39
1.70V	295.0	199.6	131.3	95.41	77.56	67.00	60.40	46.76	41.13	21.59
1.65V	300.1	208.4	134.9	97.56	78.59	67.60	61.00	47.14	41.32	21.70
1.60V	303.7	214.9	138.1	100.7	80.59	68.20	61.40	47.33	41.52	21.79

(Note) The above characteristics data are average values obtained within three charge/discharge cycle not the minimum values.

OPzV12-200(12V200Ah)



Discharge Characteristics Curve

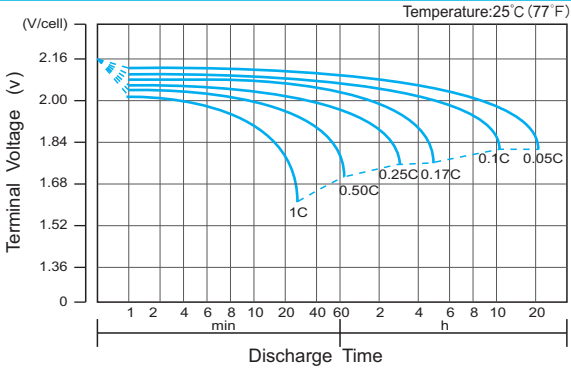

Charge Characteristic Curve for Cycle Use(IU)

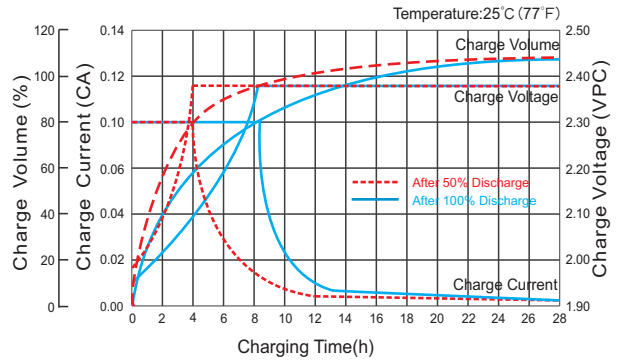

Cycle Life in Relation to Depth of Discharge

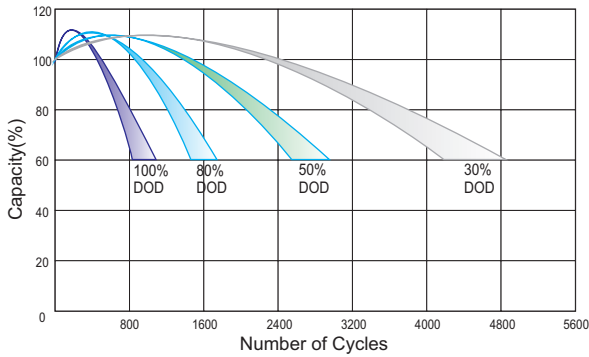

Relationship Between Charging Voltage and Temperature

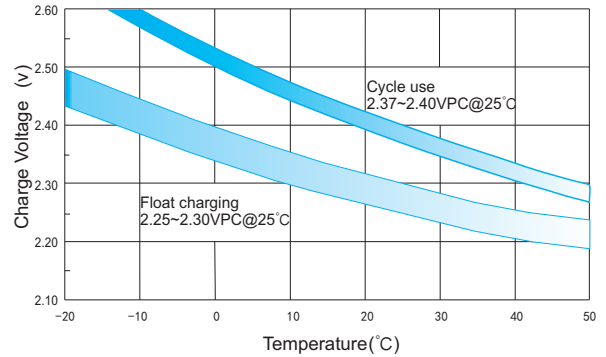

Temperature Effects on Capacity

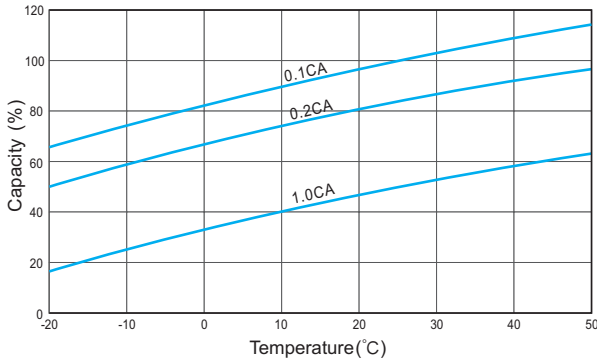

Storage Characteristics

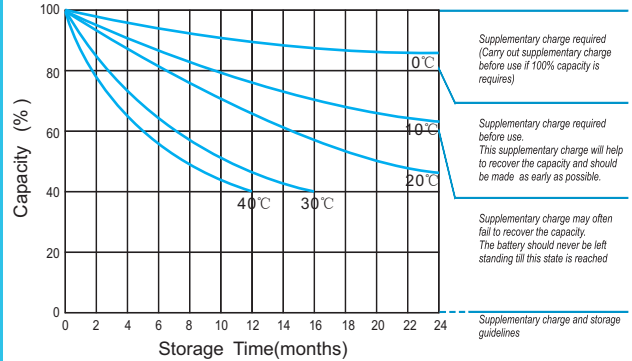

Effect of Temperature on Long Term Life

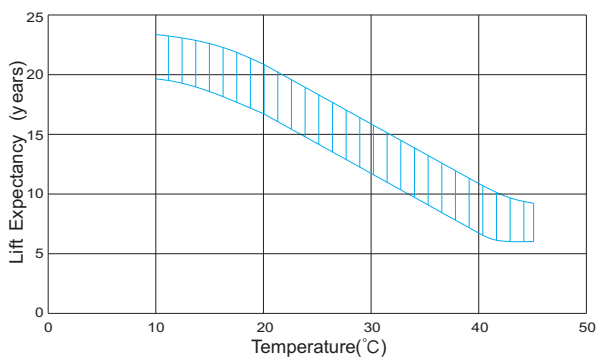

Relationship of OCV And State of Charge(20°C)

