

ADVR-073

Universal Hybrid Analog-Digital Voltage Regulator Operation Manual

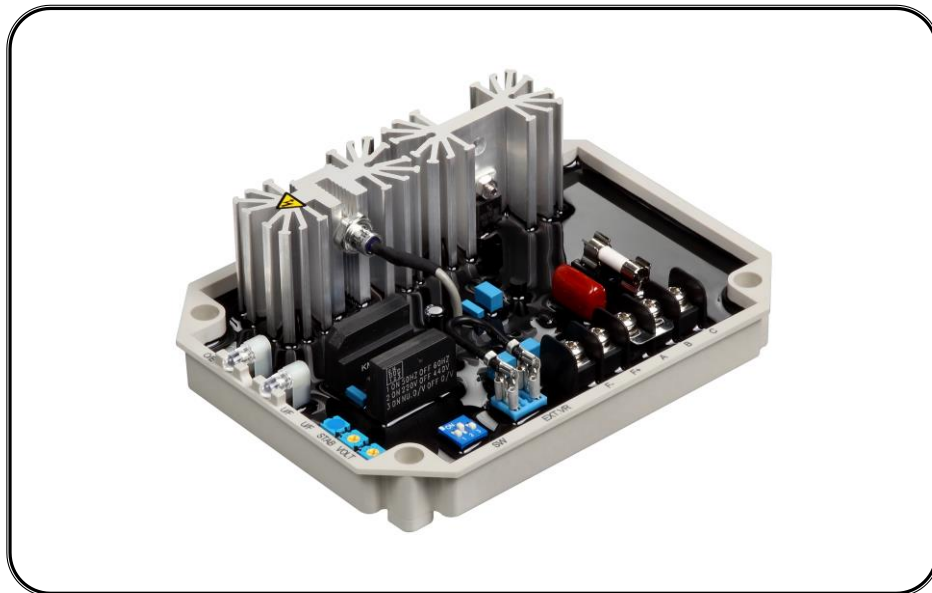

Self Excited 7 Amp Analog / Digital Voltage Regulator
For shunt and auxiliary windings generators
With over-excitation and lost of sensing protection



KUTAI ELECTRONICS INDUSTRY CO., LTD.

TEL : +886-7-8121771

FAX : +886-7-8121775

Website : www.kutai.com.tw

Headquarters : No.3, Ln. 201, Qianfu St., Qianzhen Dist., Kaohsiung City 80664, Taiwan



SECTION 1 : SUMMARY

The ADVR-073 is an advance (Hybrid Analog/Digital Voltage Regulator) design for general-purpose isochronous stand alone applications. The ADVR-073 uses an extremely reliable CPU (Central Processing Unit) in its design. This eliminates complex analogue components and circuits that are inherently over sensitive to temperature anomalies, as a result eliminating voltage instability and drift.

In addition, we added over excitation and loss of sensing shutdown protections, with matching U/F, O/E LED indicator lights. Consequently, this AVR prevents the generator from excitation overload, with its resulting exciter and regulator damage. It is easy to install and flexible for use in both shunt type and generators with auxiliary windings.

SECTION 2 : SPECIFICATION

Sensing Input

Voltage 170 – 520 Vac, 1 phase 2 wires
Frequency 50/60 Hz, DIP Switch setting

Power Input

Voltage 100 – 300 Vac, 1 phase 2 wires

Excitation Output

Voltage Max. 63 Vdc @ power input 220 Vac
Current Continuous 7A
Intermittent 15A for 10 secs.
Resistance Min. 9 ohms, Max. 100 ohms
Fuse Spec. Slow blow 5 x 20mm UDA-8A / 250V

External Voltage Adjustment

Max. +/- 7% @ 1K ohm 1 watt potentiometer

Voltage Regulation

Less than +/- 0.5% (with 4% engine governing)

Build Up Voltage

5 Vac residual volts at power input terminal

Soft Start Ramp Time

3 secs. +/- 10%

EMI Suppression

Internal electromagnetic interference filtering

Static Power Dissipation

Max.8 watts

Under Frequency Protection (Factory Presets)

50 Hz system presets knee point at 45 Hz
60 Hz system presets knee point at 55 Hz

Over Excitation Protection

Set point 78 Vdc +/- 5% @ power input 220 Vac
Time delay 5 secs. This function can be turned off.

Voltage Thermal Drift

Less than 3% at temperature range -40 to +70 °C

Environment

Operating Temperature -40 to +60 °C
Storage Temperature -40 to +85 °C
Relative Humidity Max. 95%
Vibration 3 Gs @ 100 – 2K Hz

Dimensions

150.0 (L) x 115.0 (W) x 51.5 (H) mm

Weight

430 g +/- 2%

SECTION 3 : WIRING

3.1 A to C : Sensing Input

- 3.1.1 DIP SW-2 is switch ON, voltage sensing range from 170 – 260 Vac (See Figure 3 & 4)
- 3.1.2 DIP SW-2 is switch OFF, voltage sensing range from 340 – 520 Vac (See Figure 5)

3.2 B to C : Power Input

Power Input terminals from B to either C use 100 to 300 Vac shunt or auxiliary windings.

3.3 Power Input Voltage Selection

If generator rated voltage is 220 Vac (Line to line phase voltage), the power input B, C and sensing input A, C can be joined (See Figure 4) or separately (See Figure 3).

3.4 F+, F- : Connect generator field wires

- 3.4.1 F+ and F- are the positive and negative excitation output terminals.
- 3.4.2 EXT.VR is the connections for the external voltage adjustment. Use a (1K ohm 1W) rheostat when not in use, keep terminals shorted.

※ Always use high quality connection wire AWG16 or 1.25mm² 85-degrees C, 600V to connection terminals A, B, C, F+ and F-.

SECTION 4 : DIP SWITCH SETTING

4.1 SW-1 Frequency

- 4.1.1 DIP SW-1 switch ON, for use in 50 Hz
- 4.1.2 DIP SW-1 switch OFF, for use in 60 Hz

4.2 SW-2 Sensing Voltage Selection

- 4.2.1 DIP SW-2 switch ON, input voltage 170 – 260 Vac.
- 4.2.2 DIP SW-2 switch OFF, input voltage 340 – 520 Vac.

4.3 SW-3 Activate Over-Excitation Protection

- 4.3.1 DIP SW-3 switch ON, Over Excitation Protection Disabled. If over excitation occurs, the O/E LED turns-on, but the ADVR will not shutdown and protect.
- 4.3.2 DIP SW-3 switch OFF. Over Excitation Protection activated. If over excitation occurs, the O/E LED turns-on and the ADVR will shutdown excitation.

SECTION 5 : SYSTEM PROTECTION

5.1 Under Frequency Protection (Roll off)

- 5.1.1 To prevent over excitation, if the generator runs at the wrong speed the ADVR activates the under frequency protection and decreases field excitation.
- 5.1.2 Dip switch 1 together with the U/F adjustment, sets the Knee-Point frequency where this activation takes place. This adjustment is already factory preset.

- 5.1.3 When engine frequency falls under the Knee-Point frequency setting, the U/F protection indication LED turn on. However, when the Generator frequency is higher than the Knee-Point frequency the LED turns off.

5.2 Over Excitation Protection

- 5.2.1 If you are using a standard AVR and you overload the generator or the sensing wires get disconnected (on a auxiliary powered AVR) , the excitation voltage rapidly increase, causing severe damage to the AVR or exciter. The ADVR-073 has over excitation protection shutdown that cuts excitation at once.
- 5.2.2 When over excitation protection is activated and the excitation voltage exceeds 78 +/- 5 Vdc @ 220V for over 5 seconds, the AVR immediately shutdown the excitation output, leaving only the residual voltage output and turning on the O/E shutdown LED. To reset, the engine must come to a complete stop for at least 10 seconds and then restarted.
- 5.2.3 If over excitation protection is disabled, the warning LED indication turn on, but the excitation output is not disconnected.

SECTION 6 : ADJUSTMENT

6.1 VOLT : Voltage Adjustment

- 6.1.1 DIP SW-2 switch ON, input voltage 170 – 260 Vac.
- 6.1.2 DIP SW-2 switch OFF, input voltage 340 – 520 Vac.

6.2 STAB : Stability Adjustment

- 6.2.1 careful adjust the STAB (Stability) adjustment, improves the AVR and generator feedback time to improve voltage stability.

6.3 U/F : Setting the under-frequency knee point

- 6.3.1 DIP SW-1 set to ON, set for 50 Hz operation.
- 6.3.2 U/F adjustment range at 50 Hz is from 40 – 50 Hz (Factory preset @ 45 Hz).
- 6.3.3 DIP SW-1 set to OFF, set for 60 Hz operation.
- 6.3.4 U/F adjustment range at 60 Hz is from 50 – 60 Hz (Factory preset @ 55 Hz).

SECTION 7 : STARTUP ADJUSTMENT

7.1 Voltage Adjustment (VOLT)

Set VOLT and STAB full CCW. Start generator and wait until it reaches rated frequency. Slowly adjust VOLT CW to its rated voltage. If you are using an external VR, set it first to its center position before setting volts.

7.2 Stability Adjustment (STAB)

If the generator voltage oscillates back and forth, adjust the STAB to steady the output voltage. Over adjustment, CW may give you large voltage swings when changing loads, Use an analog type voltmeter when setting STAB. Connect the voltmeter to terminals F+ and F- and slowly adjust STAB for minimum needle movement when varying load.

7.3 Under Frequency Adjustment (U/F)

To adjust the U/F setting, select working Hz using DIP SW 1, start the engine and adjust engine speed to either 55 Hz or 45 Hz slow adjust U/F until the red U/F LED turns ON. Returning the engine speed back to normal turns the LED light off.

SECTION 8 : FIELD FLASHING

When the regulator is installed correctly but the generator is failed to generate power. Besides carbon brushes were worn out, here are two possible causes below.

8.1 The polarity of field is inverse

Solution : Exchange the connection of F+ and F-.

8.2 The residual voltage is less than 5 Vac, Solution 1 :

8.2.1 Shut down generator, disconnect the wiring between AVR and generator then flash the field. Flashing duration = 3 seconds. (See wiring in Figure 1)

Resistor 3 – 5 ohms for full wave AVR
Resistor 5 – 10 ohms for half wave AVR

Warning!! Over field flashing may damage the field winding of generator.

8.2.2 Restart generator and measure the residual voltage by AC Voltmeter, if it is still less than 5 Vac, repeat the previous process, after several times, the residual voltage still cannot be built, Kutai EB500 is strongly recommended, see Figure 1.

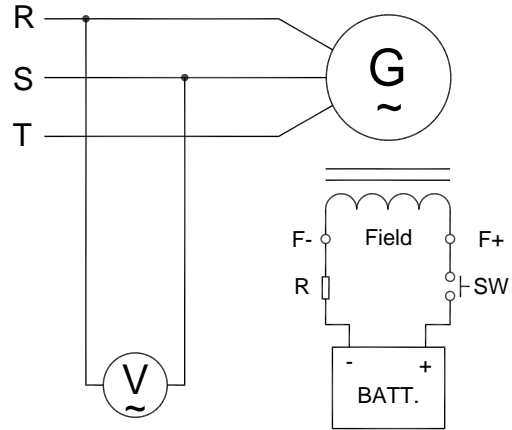

Figure 1 Manual Field Flash

WARNING

Overly field flashing may damage the AVR or generator excitation winding.

Please make sure you have read and understand the contents of the instruction manual prior to installation. Incorrect wiring connection may result in irreversible damage to the product and other equipments.

SECTION 9 : TROUBLE SHOOTING

| SYMPTOM | POSSIBLE CAUSES | SOLUTIONS |
|-----------------------------------|---|---|
| Voltage does not build up | Engine under speed | Please refer to generator service manual |
| | Low residual voltage | Please refer to section 8. Field Flashing |
| | B, C, F+, F-, Terminal connection not properly connected | Reference from Figure 3 – Figure 5 |
| | Defective generator | Please refer to generator service manual |
| Blown Fuse | Over excitation current / incorrect wiring | Reference from Figure 3 – Figure 5 |
| Low output voltage | A, C, B, C, Terminal incorrect connection | Reference from Figure 3 – Figure 5 |
| | Defective VR or not properly connected | Check connection and VR |
| | Under frequency | Please refer to generator service manual |
| | Incorrect exciter specification | Please refer to generator service manual |
| | AVR Incorrect voltage selected | Please refer to section 4. DIP Switch setting |
| Over output voltage | A, C, terminals not properly connected or incorrectly connected | Reference from Figure 3 – Figure 6 |
| | AVR Incorrect voltage selected | Please refer to section 4. DIP Switch setting |
| Output voltage unstable (Hunting) | 「STAB」 Stability incorrectly adjusted | Please refer to section 6. Adjustment |

ATTENTION

1. AVR can be mounted directly on the engine, genset, switchgear, control panel, or any position that will not affect operation. For dimension reference, please see Figure 2.
2. All voltage readings are to be taken with an average-reading voltmeter Meggers and high-potential test equipment must not be used. Use of such equipment could damage the AVR.
3. Improper setting of under-frequency protection could cause the output voltage of the unit to drop or become unstable under with changes in load. Avoid making any changes to the U/F setting unless necessary.

SECTION 10 : FIGURE AND SIZE

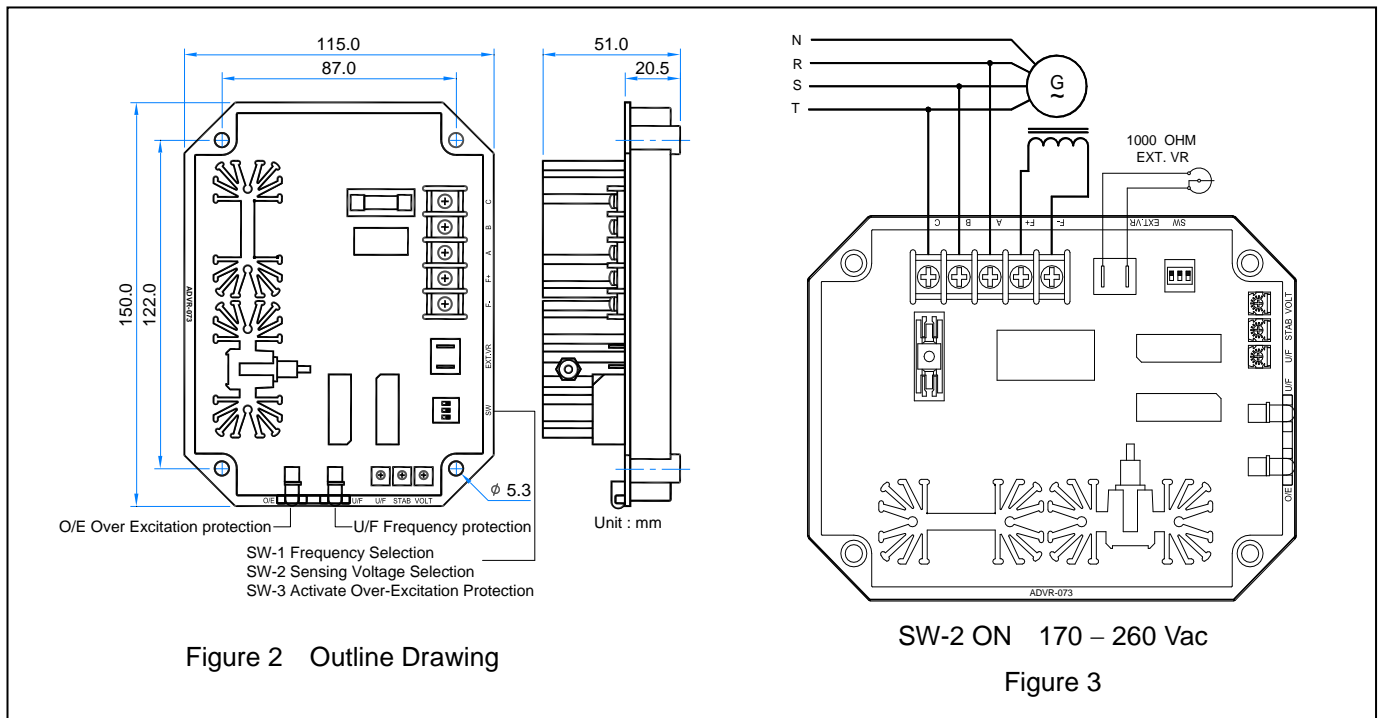

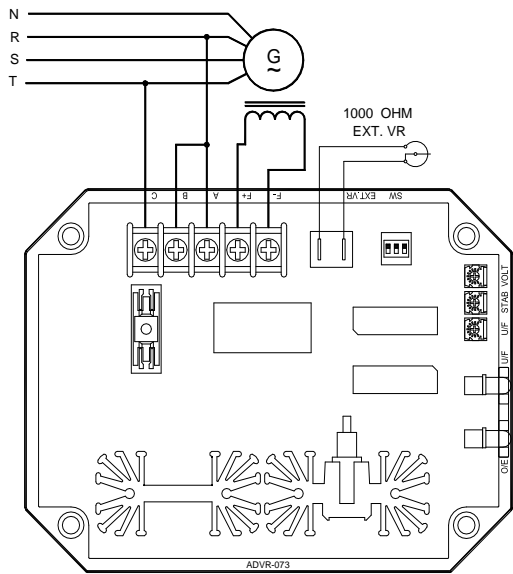

SW-2 ON 170 – 260 Vac

Figure 4

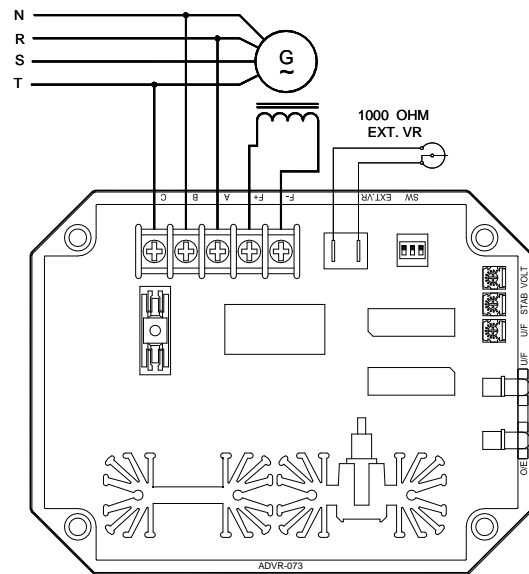

SW-2 OFF 340 – 520 Vac

Figure 5

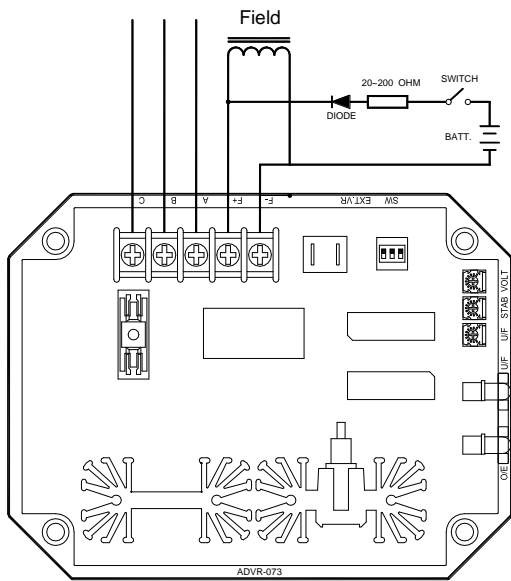

Flash With Battery

Figure 6

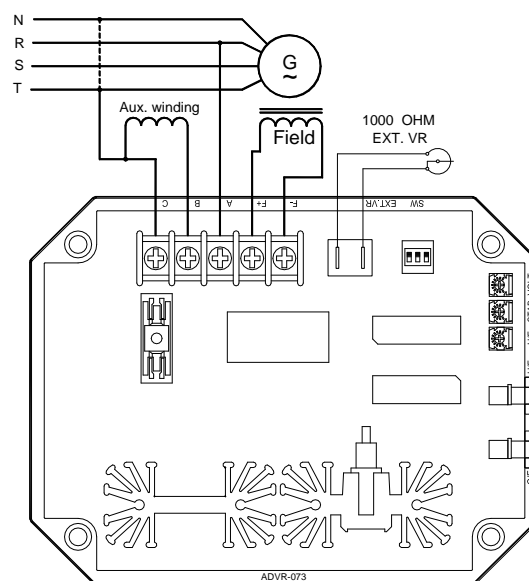

With Aux. Winding

Figure 7

- ※ Use only replacement fuses specified in this user manual.
- ※ Appearance and specifications of products are subject to change for improvement without prior notice.